









COMMERCIAL ELECTRIC (3 UNITS)

WARNING: THIS DRAWING SHOWS SUGGESTED PIPING CONFIGURATION AND OTHER DEVICES; CHECK WITH LOCAL CODES AND ORDINANCES FOR ADDITIONAL REQUIREMENTS.

LEGEND

	TEMPERATURE & PRESSURE RELIEF VALVE		FULL PORT BALL VALVE
	PRESSURE RELIEF VALVE		CHECK VALVE
	CIRCULATING PUMP		TEMPERATURE GAGE
	TANK TEMPERATURE CONTROL		WATER FLOW SWITCH
	DRAIN		

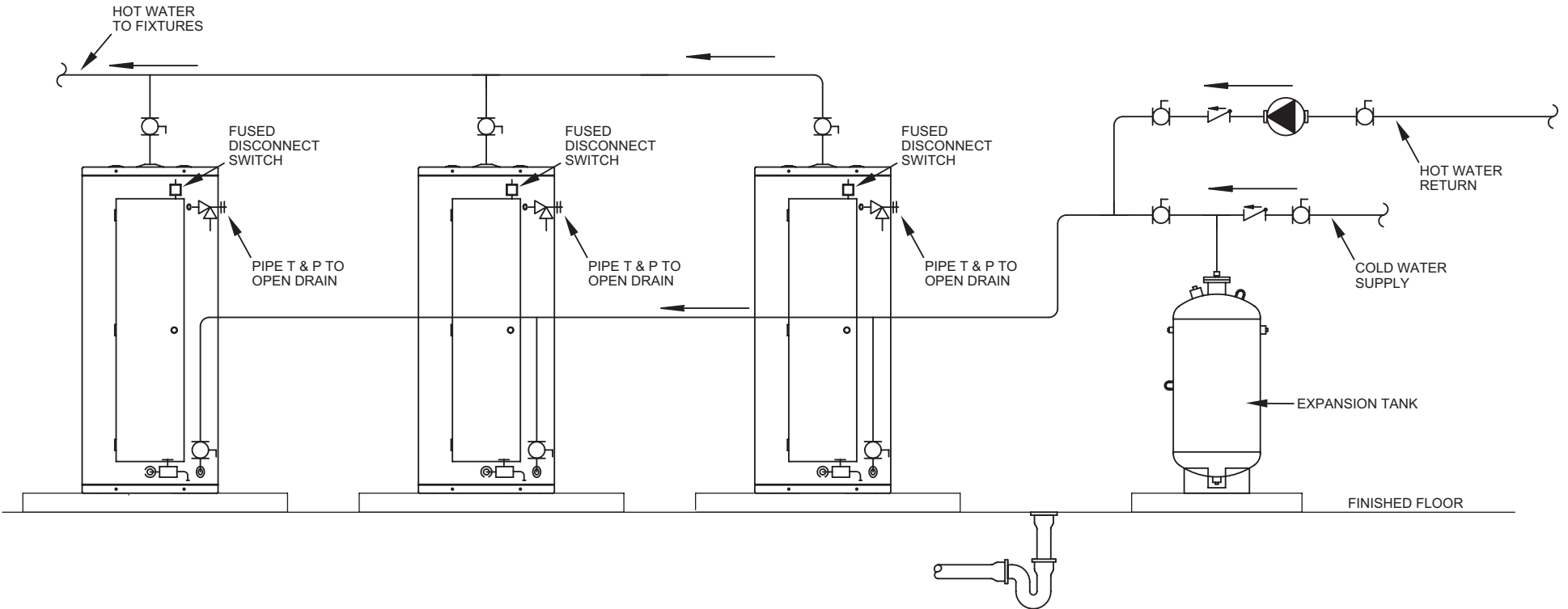

NOTES:

1. Preferred piping diagram.
2. The temperature and pressure relief valve setting shall not exceed pressure rating of any component in the system.
3. Service valves are shown for servicing unit. However, local codes shall govern their usage.